

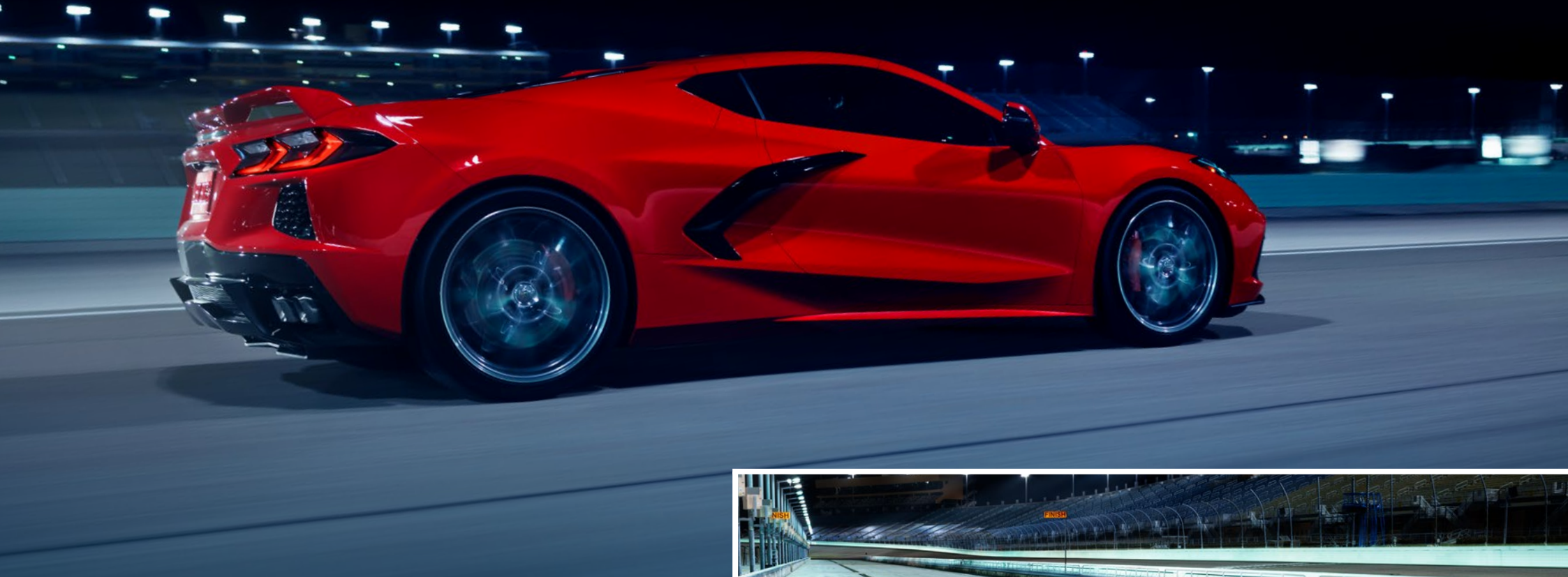

**CHEVROLET CORVETTE STINGRAY
EQUIPMENT & PRICES**

MODEL YEAR 2022

CHEVROLET CORVETTE STINGRAY



CHEVROLET CORVETTE STINGRAY



Z51 PERFORMANCE PACKAGE

THE PINNACLE OF PERFORMANCE

The architecture, structure, suspension, calibrations and software of Stingray are all ready to deliver a driving experience beyond your imagination. To reach the pinnacle, all European Corvette Stingray come standard with the Z51 Performance Package, which provides a group of performance enhancements, including:

- Z51 performance suspension
- Z51 performance Brembo® brakes
- Michelin® Pilot® Sport 4S, 245/35ZR19 front and 305/30ZR20 rear, high performance, run-flat, summer-only tires¹
- Electronic Limited Slip Differential (eLSD)
- Performance exhaust
- Performance rear axle ratio
- Heavy-duty cooling system
- Z51 rear spoiler in body color
- Z51 front splitter



¹ Do not use summer-only tires in winter conditions, as it would adversely affect vehicle safety, performance and durability. Use only GM-approved tire and wheel combinations. Unapproved combinations may change the vehicle's performance characteristics. For important tire and wheel information, please contact your Chevrolet Partner. Low-profile tires wear faster, and wheel and tire damage may occur on rough or damaged roads from surfaces or kerbs, debris or obstacles. This damage is not covered by the GM New Vehicle Limited Warranty.

PRICE TABLE

	PRICE ¹	VAT 25%	NET CONSUMER PRICE (EXCL. VAT)
Corvette Stingray Coupe 2LT	980'400 kr	196'080 kr	784'320 kr
Corvette Stingray Coupe 3LT	1'021'500 kr	204'300 kr	817'200 kr
Corvette Stingray Convertible 2LT	1'053'700 kr	210'740 kr	842'960 kr
Corvette Stingray Convertible 3LT	1'094'900 kr	218'980 kr	875'920 kr

Chevrolet Corvette Stingray 6.2L V8 - Fuel consumption, combined (l/100 km): 12.1. CO₂ emissions, combined (g/km): 277.

The WLTP figures shown have been measured as per the Worldwide Harmonised Light Vehicle Test Procedure (WLTP) according to Regulation (EC) No 715/2007 in the version valid for type-approval of the vehicle model concerned.

ENGINE

CORVETTE STINGRAY

Engine	6,2 L V8 direct-injection petrol engine with variable valve timing and Active Fuel Management (cylinder deactivation technology)
Transmission	8-speed, dual-clutch transmission
Fuel type	Petrol
Displacement	6162 cc
Bore	103.25 mm
Stroke	92.0 mm
Compression ratio	11.5 : 1
Power output	354 kW/482 hp @ 6450 rpm
Torque	613 Nm @ 4500 rpm
Top speed	296 km/h
Acceleration, 0-100 km/h	3.5 sec
Valvetrain	Overhead valve, two valves per cylinder; dual-equal variable valve timing
Oiling system	Dry sump-type, includes oil-spray piston cooling

FUEL CONSUMPTION & CO₂ EMISSIONS(WLTP)²

CORVETTE STINGRAY

Emission class	Euro 6d
Fuel consumption, combined	12.1 l/100 km
Fuel consumption, low	24.3 l/100 km
Fuel consumption, mid	12.0 l/100 km
Fuel consumption, high	9.6 l/100 km
Fuel consumption, extra-high	9.8 l/100 km
CO ₂ emissions, combined	277 g/km
CO ₂ emissions, low	555 g/km
CO ₂ emissions, mid	274 g/km
CO ₂ emissions, high	220 g/km
CO ₂ emissions, extra-high	224 g/km

¹ All prices in this price list are suggested retail prices for model year 2022, including 25% VAT.

² The WLTP figures shown have been measured as per the Worldwide Harmonised Light Vehicle Test Procedure (WLTP) according to Regulation (EC) No 715/2007 in the version valid for type-approval of the vehicle model concerned.

Figures shown are for comparability purposes; only compare fuel consumption and CO₂-emissions figures with other vehicles tested to the same technical procedures. These figures may not reflect real life driving results, which will depend upon a number of factors including the accessories fitted (post-registration), variations in weather conditions, driving styles and vehicle load. The figures do not relate to a specific vehicle and are not part of an offer.

- Standard ○ Available – Not available

CHASSIS & SUSPENSION

CORVETTE STINGRAY

Drive Axle	Rear-wheel drive
Steering	Variable-ratio rack-and-pinion with electric power assist; includes Active Steer Stops with available Magnetic Selective Ride Control
Suspension	Short / long arm (SLA) double wishbone, forged aluminum upper and cast aluminum L shape lower control arms; monotube shock absorbers (46mm)
Brakes	Front and rear e-boost-assisted discs with Brembo four-piston monobloc caliper
Launch Control	•
Driver Mode Selector	•
Active handling stability control with traction control	•
Magnetic Selective Ride Control™ suspension with Performance Traction Management	27'100 kr

EQUIPMENT

CODE

COUPE

CONVERTIBLE

2LT

3LT

2LT

3LT

CONVENIENCE

Dual-zone automatic climate control with individual climate settings for driver and passenger	•	•	•	•
Air filtration system with pollen filter	•	•	•	•
Power rake and telescopic steering column	•	•	•	•
Automatic heated steering wheel	•	•	•	•
Steering-wheel-mounted paddle shift controls	•	•	•	•
Steering wheel controls for audio, phone, Cruise Control and Driver Information Center	•	•	•	•
Memory Package - Steering wheel, outside mirrors and seat memory for driver and passenger	•	•	•	•
Rear Camera Mirror	•	•	•	•
HD front and rear vision cameras , front camera with curb view	•	•	•	•
Ultrasonic Rear Parking Assist	•	•	•	•
Front lift ³	E60	22'000 kr	22'000 kr	22'000 kr
Cruise Control	•	•	•	•
Full-color Head-Up Display, configurable	•	•	•	•
Driver and passenger power windows with express-up and -down	•	•	•	•
Headlamps, automatic on/off with tunnel detection	•	•	•	•
Automatic headlamp leveling system	•	•	•	•
Performance Data Recorder ⁴	•	•	•	•
Keyless access, push-button start	•	•	•	•
Universal Home Remote, includes garage door opener, programmable	•	•	•	•
Valet Mode	•	•	•	•
Battery protection package ⁵	ERI	1'100 kr	1'100 kr	1'100 kr
Cargo nets	•	•	•	•

³ The front lift raises the front of the vehicle approximately 50 mm in less than 3 seconds at lower speeds (up to 35-40 km/h).

⁴ The driver has to ensure compliance with privacy law and other applicable laws when using the PDR System. Such laws may in particular restrict or exclude the use of the PDR-System on public streets.

⁵ Includes a device to charge and condition the car battery, helping maintain optimum functionality when parked for long periods.

• Standard ○ Available - Not available

EQUIPMENT	CODE	COUPE		CONVERTIBLE	
		2LT	3LT	2LT	3LT

SEATING COMFORT

GT1 bucket seats		•	–	•	–
GT2 bucket seats	AH2	24'800 kr	•	24'800 kr	•
Competition Sport bucket seats	AE4	36'100 kr	11'300 kr	36'100 kr	11'300 kr
Heated and ventilated driver and passenger seats		•	•	•	•
8-way power-adjustable driver seat		•	•	•	•
8-way power-adjustable passenger seat		•	•	•	•
2-way power lumbar adjuster, driver seat		•	•	•	•
2-way power lumbar adjuster, passenger seat		•	•	•	•
Driver seat with power-adjustable seatback side bolsters		•	•	•	•
Passenger seat with power-adjustable seatback side bolsters		•	•	•	•
Two-tone seats	TU7	4'500 kr	4'500 kr	4'500 kr	4'500 kr

AUDIO & COMMUNICATION

Driver Information Center with configurable high-resolution 12" color display		•	•	•	•
Chevrolet Premium Infotainment System with navigation, 8" HD color touchscreen, voice recognition, USB ports, auxiliary audio port and SD card reader ⁶		•	•	•	•
Bose® Performance Series Sound System with 14 speakers and Active Noise Cancellation technology		•	•	•	•
Digital Audio Broadcast, DAB/DAB+/DMB-R		•	•	•	•
Wireless mobile phone charging ⁷		•	•	•	•
Smartphone integration via Apple CarPlay™ and Android Auto™ ⁸		•	•	•	•
Near Field Communication		•	•	•	•

SAFETY & SECURITY

Side Blind Zone Alert		•	•	•	•
Rear Cross-Traffic Alert		•	•	•	•
Theft deterrent system, unauthorized entry		•	•	•	•
Theft deterrent sensor, body security content		•	•	•	•
Theft deterrent sensor, vehicle inclination		•	•	•	•
Theft deterrent sensor, vehicle interior movement		•	•	•	•
Self-powered theft deterrent alarm system		•	•	•	•
Steering column lock		•	•	•	•
Airbags: driver and passenger, frontal and side impact with Passenger Sensing System		•	•	•	•
Automatic emergency call		•	•	•	•

⁶ Voice recognition is available in the following languages: English, French, German, Dutch, Italian, Polish, Danish, Portuguese, Spanish, Turkish and Russian.

⁷ The system wirelessly charges one PMA- or Qi- compatible mobile device. Mobile phone must support wireless charging for functionality.

⁸ Vehicle user interfaces are products of Apple and Google and their terms and privacy statements apply. Requires compatible smartphone and data plan rates apply. Android Auto™ requires a smartphone running Android Lollipop 5.0 OS or above; Apple CarPlay™ requires an iPhone 5 or later. Full lists of supported apps are available at Apple.com/ios/carplay and Android.com/auto. Please note that availability of apps may vary by market.

• Standard ○ Available – Not available

EQUIPMENT	CODE	COUPE		CONVERTIBLE	
		2LT	3LT	2LT	3LT

EXTERIOR

Heated, power-adjustable, power-folding, driver-side auto-dimming outside mirrors in body color, with integrated turn signal indicators		•	•	•	•
LED headlamps with daytime running functionality		•	•	•	•
Rear fog lamps		•	•	•	•
Solar-Ray® light-tinted glass		•	•	•	•
Hatch release, push button open		•	•	-	-
Trunk release, push button open		-	-	•	•
Tailpipe, bright		•	•	•	•
Capless fueling system		•	•	•	•
Engine Appearance Package with carbon-fiber closeout panels	ZZ3	9'000 kr	9'000 kr	-	-
Aero Delete Package - Removes rear spoiler and front splitter	ZF1	0 kr	0 kr	0 kr	0 kr
Carbon Flash accents package - Rear spoiler and outside mirrors	ZYC	16'900 kr	16'900 kr	16'900 kr	16'900 kr
Carbon Flash exterior trim - Side vents, front/rear grille (and tonneau grille on convertible)		•	•	•	•
Body-color exterior trim - Side vents, front/rear grille (and tonneau grille on convertible) ⁹	EFY	5'600 kr	5'600 kr	5'600 kr	5'600 kr
Shadow Gray exterior trim - Side vents, front/rear grille (and tonneau grille on convertible)	EFA	5'600 kr	5'600 kr	5'600 kr	5'600 kr
Exterior badges in Carbon Flash		•	•	•	•
Exterior badges in chrome	EYK	3'400 kr	3'400 kr	3'400 kr	3'400 kr
Body-color roof panel ¹⁰		•	•	-	-
Transparent roof panel ¹⁰	CC3	10'700 kr	10'700 kr	-	-
Visible carbon fiber roof panel with body-color surround ¹⁰	C2Z	20'900 kr	20'900 kr	-	-
Dual roof panel package: one body-color and one transparent ¹⁰	C2Q	20'900 kr	20'900 kr	-	-
Dual roof panel package: one transparent and one visible carbon fiber with body-color surround ¹⁰	C2M	31'600 kr	31'600 kr	-	-



Body-color roof panel (standard)



Transparent roof panel (CC3)



Visible carbon fiber roof panel with body-color surround (C2Z)



Dual roof panel package: one body-color and one transparent (C2Q)



Dual roof panel package: one transparent and one visible carbon fiber with body-color surround (C2M)

⁹ Not available with exterior color Black.

¹⁰ Removable, stores securely in the rear trunk.
 • Standard ○ Available - Not available

EQUIPMENT	CODE	COUPE		CONVERTIBLE	
		2LT	3LT	2LT	3LT
Power-retractable convertible hardtop ¹¹		-	-	•	•
Carbon Flash nacelles and body-color roof ¹²	D86	-	-	6'800 kr	6'800 kr
Carbon Flash nacelles and roof ¹²	D84	-	-	16'900 kr	16'900 kr



standard



Carbon Flash nacelles and body-color roof (D86)



Carbon Flash nacelles and roof (D84)

5-open-spoke Bright Silver-painted aluminum wheels: 19 X 8.5 J front and 20 X 11.0 J rear		•	•	•	•
5-open-spoke Carbon Flash-painted aluminum wheels with machined edge: 19 X 8.5 J front and 20 X 11.0 J rear	Q8Q	10'700 kr	10'700 kr	10'700 kr	10'700 kr
5-trident-spoke machined-face Sterling Silver-painted aluminum wheels: 19 X 8.5 J front and 20 X 11.0 J rear	Q8S	16'400 kr	16'400 kr	16'400 kr	16'400 kr
5-trident-spoke machined-face Spectra Gray-painted aluminum wheels: 19 X 8.5 J front and 20 X 11.0 J rear	Q8T	16'400 kr	16'400 kr	16'400 kr	16'400 kr



5-open-spoke Bright Silver-painted aluminum wheels: 19 X 8.5 J front and 20 X 11.0 J rear (standard)



5-open-spoke Carbon Flash-painted aluminum wheels with machined edge: 19 X 8.5 J front and 20 X 11.0 J rear (Q8Q)



5-trident-spoke machined-face Sterling Silver-painted aluminum wheels: 19 X 8.5 J front and 20 X 11.0 J rear (Q8S)



5-trident-spoke machined-face Spectra Gray-painted aluminum wheels: 19 X 8.5 J front and 20 X 11.0 J rear (Q8T)

Black-painted brake calipers		•	•	•	•
Bright Red-painted brake calipers	J6F	6'800 kr	6'800 kr	6'800 kr	6'800 kr
Edge Red-painted brake calipers	J6N	6'800 kr	6'800 kr	6'800 kr	6'800 kr
Edge Yellow-painted brake calipers	J6E	6'800 kr	6'800 kr	6'800 kr	6'800 kr



Black-painted brake calipers (standard)



Bright Red-painted brake calipers (J6F)



Edge Red-painted brake calipers (J6N)



Edge Yellow-painted brake calipers (J6E)

¹¹ Convertible hardtop can be raised or lowered while driving at speeds up to 50 km/h. Operates with the press of a button (up or down) or remotely using the key fob (down only).

¹² Not available with exterior color Black

• Standard ○ Available - Not available

EQUIPMENT	CODE	COUPE		CONVERTIBLE	
		2LT	3LT	2LT	3LT
		Carbon Flash full length dual racing stripes	DTH	9'000 kr	9'000 kr
Midnight Gray full length dual racing stripes	DX0	9'000 kr	9'000 kr	9'000 kr	9'000 kr
Sterling Silver full length dual racing stripes	DUB	9'000 kr	9'000 kr	9'000 kr	9'000 kr
Edge Red full length dual racing stripes ¹³	DSZ	9'000 kr	9'000 kr	9'000 kr	9'000 kr
Edge Yellow full length dual racing stripes ¹⁴	DT0	9'000 kr	9'000 kr	9'000 kr	9'000 kr
Edge Orange full length dual racing stripes ¹⁵	DSY	9'000 kr	9'000 kr	9'000 kr	9'000 kr
Edge Blue full length dual racing stripes ¹⁶	DUW	9'000 kr	9'000 kr	9'000 kr	9'000 kr
Midnight Silver/Carbon Flash stinger hood stripe	DZV	4'500 kr	4'500 kr	4'500 kr	4'500 kr
Edge Red/Carbon Flash stinger hood stripe ¹³	DZX	4'500 kr	4'500 kr	4'500 kr	4'500 kr
Edge Yellow/Carbon Flash stinger hood stripe ¹⁴	DZU	4'500 kr	4'500 kr	4'500 kr	4'500 kr



Carbon Flash full length dual racing stripes (DTH)



Midnight Gray full length dual racing stripes (DX0)



Sterling Silver full length dual racing stripes (DUB)



Edge Red full length dual racing stripes (DSZ)



Edge Yellow full length dual racing stripes (DT0)



Edge Orange full length dual racing stripes (DSY)



Edge Blue full length dual racing stripes (DUW)



Midnight Silver/Carbon Flash stinger hood stripe (DZV)



Edge Red/Carbon Flash stinger hood stripe (DZX)



Edge Yellow/Carbon Flash stinger hood stripe (DZU)

¹³ Not available with exterior colors Torch Red and Tactical Red Tintcoat.

¹⁴ Not available with exterior color Accelerate Yellow Metallic.

¹⁵ Not available with exterior color Amplify Orange Tintcoat.

¹⁶ Not available with exterior colors Elkhart Lake Blue Metallic and Rapid Blue.

• Standard ○ Available – Not available

EQUIPMENT	CODE	COUPE		CONVERTIBLE	
		2LT	3LT	2LT	3LT

INTERIOR

Leather-wrapped steering wheel, flat top and bottom		•	•	•	•
Sueded microfiber-wrapped steering wheel, flat top and bottom		○	○	○	○
Leather-wrapped interior package - Upper instrument panel, door panels and console cover		-	•	-	•
Sueded microfiber-wrapped upper interior trim - Headliner, visors and A-pillar trim		-	•	-	•
Adrenaline Red stitching ¹⁷	38S	-	9'000 kr	-	9'000 kr
Yellow stitching ¹⁷	36S	-	9'000 kr	-	9'000 kr
Carbon fiber interior trim- Cluster-surround and console/door switch plates	FA5	16'900 kr	16'900 kr	16'900 kr	16'900 kr
Carpeted floor mats		•	•	•	•
Power outlets		•	•	•	•
Black seat belts	719	0 kr	0 kr	0 kr	0 kr
Tan seat belts	3N9	4'500 kr	4'500 kr	4'500 kr	4'500 kr
Torch Red seat belts	3F9	4'500 kr	4'500 kr	4'500 kr	4'500 kr
Yellow seat belts	3M9	4'500 kr	4'500 kr	4'500 kr	4'500 kr
Orange seat belts	379	4'500 kr	4'500 kr	4'500 kr	4'500 kr
Tension Blue seat belts	3A9	4'500 kr	4'500 kr	4'500 kr	4'500 kr



Black seat belts (719)



Tan seat belts (3N9)

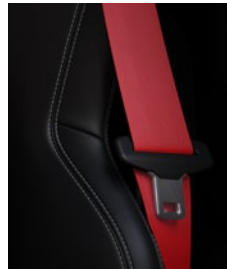

Torch Red seat belts (3F9)

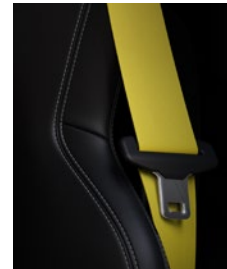

Yellow seat belts (3M9)



Orange seat belts (379)



Tension Blue seat belts (3A9)

¹⁷ With Jet Black interior only. Adds console and door panel in sueded microfiber.

• Standard ○ Available - Not available

EXTERIOR COLORS	CODE	COUPE		CONVERTIBLE	
		2LT	3LT	2LT	3LT
		Black	GBA	0 kr	0 kr
Arctic White	G8G	0 kr	0 kr	0 kr	0 kr
Torch Red	GKZ	0 kr	0 kr	0 kr	0 kr
Flare Silver Metallic	GSJ	13'500 kr	13'500 kr	13'500 kr	13'500 kr
Hypersonic Gray Metallic	GA7	13'500 kr	13'500 kr	13'500 kr	13'500 kr
Caffeine Brown Metallic	G48	13'500 kr	13'500 kr	13'500 kr	13'500 kr
Accelerate Yellow Metallic	GDO	13'500 kr	13'500 kr	13'500 kr	13'500 kr
Elkhart Lake Blue Metallic	GS7	13'500 kr	13'500 kr	13'500 kr	13'500 kr
Rapid Blue	GM0	13'500 kr	13'500 kr	13'500 kr	13'500 kr
Ceramic Matrix Gray Metallic	G9F	13'500 kr	13'500 kr	13'500 kr	13'500 kr
Amplify Orange Tintcoat	GC5	24'800 kr	24'800 kr	24'800 kr	24'800 kr
Tactical Red Tintcoat	GPH	24'800 kr	24'800 kr	24'800 kr	24'800 kr



Black (GBA)



Arctic White (G8G)



Torch Red (GKZ)



Flare Silver Metallic (GSJ)



Hypersonic Gray Metallic (GA7)



Caffeine Brown Metallic (G48)



Accelerate Yellow Metallic (GDO)



Elkhart Lake Blue Metallic (GS7)



Rapid Blue (GM0)



Ceramic Matrix Gray Metallic (G9F)



Amplify Orange Tintcoat (GC5)



Tactical Red Tintcoat (GPH)

• Standard ○ Available – Not available

INTERIOR COLORS	CODE	COUPE		CONVERTIBLE	
		2LT	3LT	2LT	3LT
Jet Black Mulan leather with perforated leather seating surfaces	HTA	0 kr	-	0 kr	-
Sky Cool Gray Mulan leather with perforated leather seating surfaces	HUN	0 kr	-	0 kr	-
Adrenaline Red Mulan leather with perforated leather seating surfaces	HUR	0 kr	-	0 kr	-
Natural Mulan leather with perforated leather seating surfaces	HUV	0 kr	-	0 kr	-
Jet Black Nappa leather with perforated leather seating surfaces	HTM	0 kr	-	0 kr	-
Jet Black Nappa leather with seating surfaces and steering wheel in perforated sueded microfiber	HTP	11'300 kr	-	11'300 kr	-
Sky Cool Gray Nappa leather with perforated leather seating surfaces	HUK	0 kr	-	0 kr	-
Sky Cool Gray Nappa leather with perforated leather seating surfaces (two-tone)	HUK+TU7	4'500 kr	-	4'500 kr	-
Sky Cool Gray Nappa leather with seating surfaces and steering wheel in perforated sueded microfiber	HU6	11'300 kr	-	11'300 kr	-
Sky Cool Gray Nappa leather with seating surfaces and steering wheel in perforated sueded microfiber (two-tone)	HU6+TU7	15'800 kr	-	15'800 kr	-
Adrenaline Red Nappa leather with perforated leather seating surfaces	HUL	0 kr	-	0 kr	-
Adrenaline Red Nappa leather with perforated leather seating surfaces (two-tone)	HUL+TU7	4'500 kr	-	4'500 kr	-
Adrenaline Red leather with seating surfaces and steering wheel in perforated sueded microfiber	HU7	11'300 kr	-	11'300 kr	-
Adrenaline Red leather with seating surfaces and steering wheel in perforated sueded microfiber (two-tone)	HU7+TU7	15'800 kr	-	15'800 kr	-
Natural Nappa leather with perforated leather seating surfaces	HTN	0 kr	-	0 kr	-
Natural Nappa leather with perforated leather seating surfaces (two-tone)	HTN+TU7	4'500 kr	-	4'500 kr	-
Natural Nappa leather with seating surfaces and steering wheel in perforated sueded microfiber	HTQ	11'300 kr	-	11'300 kr	-
Natural Nappa leather with seating surfaces and steering wheel in perforated sueded microfiber (two-tone)	HTQ+TU7	15'800 kr	-	15'800 kr	-
Jet Black Nappa leather with perforated leather seating surfaces	HTE	-	0 kr	-	0 kr
Jet Black Nappa leather with seating surfaces and steering wheel in perforated sueded microfiber	HTT	-	11'300 kr	-	11'300 kr
Sky Cool Gray Nappa leather with perforated leather seating surfaces	HU1	-	0 kr	-	0 kr
Sky Cool Gray Nappa leather with perforated leather seating surfaces (two-tone)	HU1+TU7	-	4'500 kr	-	4'500 kr
Sky Cool Gray Nappa leather with seating surfaces and steering wheel in perforated sueded microfiber	HU9	-	11'300 kr	-	11'300 kr
Sky Cool Gray Nappa leather with seating surfaces and steering wheel in perforated sueded microfiber (two-tone)	HU9+TU7	-	15'800 kr	-	15'800 kr
Adrenaline Red Nappa leather with perforated leather seating surfaces	HU2	-	0 kr	-	0 kr
Adrenaline Red Nappa leather with perforated leather seating surfaces (two-tone)	HU2+TU7	-	4'500 kr	-	4'500 kr
Adrenaline Red leather with seating surfaces and steering wheel in perforated sueded microfiber	HUA	-	11'300 kr	-	11'300 kr
Adrenaline Red leather with seating surfaces and steering wheel in perforated sueded microfiber (two-tone)	HUA+TU7	-	15'800 kr	-	15'800 kr
Natural Nappa leather with perforated leather seating surfaces	HUE	-	0 kr	-	0 kr
Natural Nappa leather with perforated leather seating surfaces (two-tone)	HUE+TU7	-	4'500 kr	-	4'500 kr
Natural Nappa leather with seating surfaces and steering wheel in perforated sueded microfiber	HTG	-	11'300 kr	-	11'300 kr
Natural Nappa leather with seating surfaces and steering wheel in perforated sueded microfiber (two-tone)	HTG+TU7	-	15'800 kr	-	15'800 kr
Natural Dipped Nappa leather with perforated leather seating surfaces ¹⁸	HZN	-	0 kr	-	0 kr
Natural Dipped Nappa leather with seating surfaces and steering wheel in perforated sueded microfiber ¹⁸	HUF	-	11'300 kr	-	11'300 kr
Morello Red Dipped Nappa leather with perforated leather seating surfaces ¹⁹	HU3	-	0 kr	-	0 kr
Tension/Twilight Blue Dipped Nappa leather with perforated leather seating surfaces ²⁰	HTO	-	0 kr	-	0 kr



















¹⁸ Full color interior: instrument panel, doors, carpet and seat belts in Natural. Console and door panel are in sueded microfiber.

¹⁹ Full color interior: instrument panel, doors and carpet in Morello Red. Console and door panel are in sueded microfiber.

²⁰ Full color interior: instrument panel, doors and carpet in Tension/Twilight Blue. Seat belts are in Tension Blue.

• Standard ○ Available - Not available

INTERIOR / EXTERIOR COLOR AVAILABILITY

		EXTERIOR COLORS											
		Black (GBA)	Arctic White (G8G)	Torch Red (GKZ)	Flare Silver Metallic (GSJ)	Hypersonic Gray Metallic (GA7)	Caffeine Brown Metallic (G48)	Accelerate Yellow Metallic (GD0)	Elkhart Lake Blue Metallic (GS7)	Rapid Blue (GMO)	Ceramic Matrix Gray Metallic (G9F)	Amplify Orange Tintcoat (GC5)	Tactical Red Tintcoat (GPH)
INTERIOR COLORS													
	Jet Black	○	○	○	○	○	○	○	○	○	○	○	○
	Sky Cool Gray	○	○	○	○	○	○	○	○	○	○	○	○
	Adrenaline Red	○	○	○	○	○	-	-	-	-	○	-	-
	Natural	○	○	○	○	○	○	○	○	○	○	○	○
	Morello Red	○	○	-	○	○	-	-	-	-	○	-	○
	Tension/Twilight Blue	○	○	-	○	○	-	-	○	○	○	-	-

● Standard ○ Available - Not available

2LT INTERIORS

GT1 SEATS A Q9

Mulan leather with perforated leather seating surfaces

2LT
LEATHER















SUEDE

AVAILABLE
SEAT BELTS

AVAILABLE EXTERIOR COLORS

JET BLACK



HTA 0 kr	-	 Black (719, strd.)	 Tan (3N9)	 Torch Red (3F9)	 Black (GBA)	 Hypersonic Gray Metallic (GA7)	 Arctic White (G8G)	 Ceramic Matrix Gray Metallic (G9F)	 Flare Silver Metallic (GSJ)	 Accelerate Yellow Metallic (GDD)
		 Yellow (3M9)	 Orange (379)	 Tension Blue (3A9)	 Amplify Orange Tintcoat (GC5)	 Torch Red (GKZ)	 Tactical Red Tintcoat (GPH)	 Caffeine Brown Metallic (G48)	 Rapid Blue (GMO)	 Elkhart Lake Blue Metallic (GS7)









SKY COOL GRAY



HUN 0 kr	-	 Black (719, strd.)	 Torch Red (3F9)	 Black (GBA)	 Hypersonic Gray Metallic (GA7)	 Arctic White (G8G)	 Ceramic Matrix Gray Metallic (G9F)	 Flare Silver Metallic (GSJ)	 Accelerate Yellow Metallic (GDD)
		 Yellow (3M9)	 Orange (379)	 Tension Blue (3A9)	 Amplify Orange Tintcoat (GC5)	 Torch Red (GKZ)	 Tactical Red Tintcoat (GPH)	 Caffeine Brown Metallic (G48)	 Rapid Blue (GMO)

ADRENALINE RED



HUR 0 kr	-	 Black (719, strd.)	 Torch Red (3F9)	 Black (GBA)	 Hypersonic Gray Metallic (GA7)	 Arctic White (G8G)	 Ceramic Matrix Gray Metallic (G9F)	 Flare Silver Metallic (GSJ)
				 Torch Red (GKZ)				

NATURAL



HUV 0 kr	-	 Black (719, strd.)	 Tan (3N9)	 Torch Red (3F9)	 Black (GBA)	 Hypersonic Gray Metallic (GA7)	 Arctic White (G8G)	 Ceramic Matrix Gray Metallic (G9F)	 Flare Silver Metallic (GSJ)	 Accelerate Yellow Metallic (GDD)
		 Yellow (3M9)	 Orange (379)	 Tension Blue (3A9)	 Amplify Orange Tintcoat (GC5)	 Torch Red (GKZ)	 Tactical Red Tintcoat (GPH)	 Caffeine Brown Metallic (G48)	 Rapid Blue (GMO)	 Elkhart Lake Blue Metallic (GS7)

• Standard ○ Available - Not available

2LT INTERIORS

GT2 SEATS AH2

Nappa leather with perforated leather seating surfaces /
Nappa leather with seating surfaces and steering wheel in perforated sueded microfiber

2LT AVAILABLE SEAT BELTS AVAILABLE EXTERIOR COLORS

JET BLACK

		HTM	HTP									
		0 kr	11'300 kr	Black (719, strd.)	Tan (3N9)	Torch Red (3F9)	Black (GBA)	Hypersonic Gray Metallic (GA7)	Arctic White (G8G)	Ceramic Matrix Gray Metallic (G9F)	Flare Silver Metallic (GSJ)	Accelerate Yellow Metallic (GDD)
				Yellow (3M9)	Orange (379)	Tension Blue (3A9)	Amplify Orange Tintcoat (GC5)	Torch Red (GKZ)	Tactical Red Tintcoat (GPH)	Caffeine Brown Metallic (G48)	Rapid Blue (GMO)	Elkhart Lake Blue Metallic (GS7)

SKY COOL GRAY

		HUK	HU6									
		0 kr	11'300 kr	Black (719, strd.)	Torch Red (3F9)	Black (GBA)	Hypersonic Gray Metallic (GA7)	Arctic White (G8G)	Ceramic Matrix Gray Metallic (G9F)	Flare Silver Metallic (GSJ)	Accelerate Yellow Metallic (GDD)	
				Yellow (3M9)	Orange (379)	Tension Blue (3A9)	Amplify Orange Tintcoat (GC5)	Torch Red (GKZ)	Tactical Red Tintcoat (GPH)	Caffeine Brown Metallic (G48)	Rapid Blue (GMO)	Elkhart Lake Blue Metallic (GS7)

ADRENALINE RED

		HUL	-								
		0 kr		Black (719, strd.)	Torch Red (3F9)	Black (GBA)	Hypersonic Gray Metallic (GA7)	Arctic White (G8G)	Ceramic Matrix Gray Metallic (G9F)	Flare Silver Metallic (GSJ)	
							Torch Red (GKZ)				

NATURAL

		HTN	HTQ									
		0 kr	11'300 kr	Black (719, strd.)	Tan (3N9)	Torch Red (3F9)	Black (GBA)	Hypersonic Gray Metallic (GA7)	Arctic White (G8G)	Ceramic Matrix Gray Metallic (G9F)	Flare Silver Metallic (GSJ)	Accelerate Yellow Metallic (GDD)
				Yellow (3M9)	Orange (379)	Tension Blue (3A9)	Amplify Orange Tintcoat (GC5)	Torch Red (GKZ)	Tactical Red Tintcoat (GPH)	Caffeine Brown Metallic (G48)	Rapid Blue (GMO)	Elkhart Lake Blue Metallic (GS7)

• Standard ○ Available - Not available

2LT INTERIORS





GT2 SEATS AH2+TU7 (TWO-TONE)

Nappa leather with perforated leather seating surfaces /
Nappa leather with seating surfaces and steering wheel in perforated sueded microfiber

2LT AVAILABLE SEAT BELTS AVAILABLE EXTERIOR COLORS









SKY COOL GRAY



2LT LEATHER	2LT SUEDE	AVAILABLE SEAT BELTS			AVAILABLE EXTERIOR COLORS							
HUK + TU7	HU6 + TU7											
4'500 kr	15'800 kr	Black (719, strd.)	Torch Red (3F9)	Amplify Orange Tintcoat (GC5)	Torch Red (GKZ)	Tactical Red Tintcoat (GPH)	Caffeine Brown Metallic (G48)	Rapid Blue (GMO)	Elkhart Lake Blue Metallic (GS7)			
												
		Yellow (3M9)	Orange (379)									











ADRENALINE RED



2LT LEATHER	2LT SUEDE	AVAILABLE SEAT BELTS			AVAILABLE EXTERIOR COLORS							
HUL + TU7	HU7 + TU7											
4'500 kr	15'800 kr	Black (719, strd.)	Torch Red (3F9)									
												
				Torch Red (GKZ)								

NATURAL



2LT LEATHER	2LT SUEDE	AVAILABLE SEAT BELTS			AVAILABLE EXTERIOR COLORS							
HTN + TU7	HTQ + TU7											
4'500 kr	15'800 kr	Black (719, strd.)	Tan (3N9)	Amplify Orange Tintcoat (GC5)	Torch Red (GKZ)	Tactical Red Tintcoat (GPH)	Caffeine Brown Metallic (G48)	Rapid Blue (GMO)	Elkhart Lake Blue Metallic (GS7)			
												
		Yellow (3M9)	Orange (379)									

2LT INTERIORS

















COMPETITION SPORT SEATS AE4

Nappa leather with perforated leather seating surfaces /
Nappa leather with seating surfaces and steering wheel in perforated sueded microfiber

2LT LEATHER SUEDE AVAILABLE SEAT BELTS AVAILABLE EXTERIOR COLORS









JET BLACK



HTM	HTP	 Black (719, strd.)	 Tan (3N9)	 Torch Red (3F9)	 Black (GBA)	 Hypersonic Gray Metallic (GA7)	 Arctic White (G8G)	 Ceramic Matrix Gray Metallic (G9F)	 Flare Silver Metallic (GSJ)	 Accelerate Yellow Metallic (GDD)
0 kr	11'300 kr	 Yellow (3M9)	 Orange (379)	 Tension Blue (3A9)	 Amplify Orange Tintcoat (GC5)	 Torch Red (GKZ)	 Tactical Red Tintcoat (GPH)	 Caffeine Brown Metallic (G48)	 Rapid Blue (GMO)	 Elkhart Lake Blue Metallic (GS7)

ADRENALINE RED



HUL	HU7	 Black (719, strd.)	 Torch Red (3F9)	 Black (GBA)	 Hypersonic Gray Metallic (GA7)	 Arctic White (G8G)	 Ceramic Matrix Gray Metallic (G9F)	 Flare Silver Metallic (GSJ)		
0 kr	11'300 kr			 Torch Red (GKZ)						

NATURAL



HTN	HTQ	 Black (719, strd.)	 Tan (3N9)	 Torch Red (3F9)	 Black (GBA)	 Hypersonic Gray Metallic (GA7)	 Arctic White (G8G)	 Ceramic Matrix Gray Metallic (G9F)	 Flare Silver Metallic (GSJ)	 Accelerate Yellow Metallic (GDD)
0 kr	11'300 kr	 Yellow (3M9)	 Orange (379)	 Tension Blue (3A9)	 Amplify Orange Tintcoat (GC5)	 Torch Red (GKZ)	 Tactical Red Tintcoat (GPH)	 Caffeine Brown Metallic (G48)	 Rapid Blue (GMO)	 Elkhart Lake Blue Metallic (GS7)

• Standard ○ Available – Not available

3LT INTERIORS



















GT2 SEATS AH2

Nappa leather with perforated leather seating surfaces /
Nappa leather with seating surfaces and steering wheel in perforated sueded microfiber

3LT AVAILABLE SEAT BELTS AVAILABLE EXTERIOR COLORS

JET BLACK



LEATHER	SUEDE	AVAILABLE SEAT BELTS			AVAILABLE EXTERIOR COLORS					
HTE	HTT	 Black (719, strd.)	 Tan (3N9)	 Torch Red (3F9)	 Black (GBA)	 Hypersonic Gray Metallic (GA7)	 Arctic White (G8G)	 Ceramic Matrix Gray Metallic (G9F)	 Flare Silver Metallic (GSJ)	 Accelerate Yellow Metallic (GDD)
0 kr	11'300 kr	 Yellow (3M9)	 Orange (379)	 Tension Blue (3A9)	 Amplify Orange Tintcoat (GC5)	 Torch Red (GKZ)	 Tactical Red Tintcoat (GPH)	 Caffeine Brown Metallic (G48)	 Rapid Blue (GMO)	 Elkhart Lake Blue Metallic (GS7)









SKY COOL GRAY



LEATHER	SUEDE	AVAILABLE SEAT BELTS			AVAILABLE EXTERIOR COLORS					
HU1	HU9	 Black (719, strd.)		 Torch Red (3F9)	 Black (GBA)	 Hypersonic Gray Metallic (GA7)	 Arctic White (G8G)	 Ceramic Matrix Gray Metallic (G9F)	 Flare Silver Metallic (GSJ)	 Accelerate Yellow Metallic (GDD)
0 kr	11'300 kr	 Yellow (3M9)	 Orange (379)	 Tension Blue (3A9)	 Amplify Orange Tintcoat (GC5)	 Torch Red (GKZ)	 Tactical Red Tintcoat (GPH)	 Caffeine Brown Metallic (G48)	 Rapid Blue (GMO)	 Elkhart Lake Blue Metallic (GS7)



















ADRENALINE RED



LEATHER	SUEDE	AVAILABLE SEAT BELTS			AVAILABLE EXTERIOR COLORS					
HU2	-	 Black (719, strd.)		 Torch Red (3F9)	 Black (GBA)	 Hypersonic Gray Metallic (GA7)	 Arctic White (G8G)	 Ceramic Matrix Gray Metallic (G9F)	 Flare Silver Metallic (GSJ)	
0 kr						 Torch Red (GKZ)				

NATURAL



LEATHER	SUEDE	AVAILABLE SEAT BELTS			AVAILABLE EXTERIOR COLORS					
HUE	HTG	 Black (719, strd.)	 Tan (3N9)	 Torch Red (3F9)	 Black (GBA)	 Hypersonic Gray Metallic (GA7)	 Arctic White (G8G)	 Ceramic Matrix Gray Metallic (G9F)	 Flare Silver Metallic (GSJ)	 Accelerate Yellow Metallic (GDD)
0 kr	11'300 kr	 Yellow (3M9)	 Orange (379)	 Tension Blue (3A9)	 Amplify Orange Tintcoat (GC5)	 Torch Red (GKZ)	 Tactical Red Tintcoat (GPH)	 Caffeine Brown Metallic (G48)	 Rapid Blue (GMO)	 Elkhart Lake Blue Metallic (GS7)

• Standard ○ Available - Not available

3LT INTERIORS



















GT2 SEATS AH2

Nappa leather with perforated leather seating surfaces /
Nappa leather with seating surfaces and steering wheel in perforated sueded microfiber

3LT AVAILABLE SEAT BELTS AVAILABLE EXTERIOR COLORS









NATURAL DIPPED ²¹



3LT LEATHER	3LT SUEDE	AVAILABLE SEAT BELTS			AVAILABLE EXTERIOR COLORS					
HZN	HUF									
0 kr	11'300 kr	Black (719)	Tan (3N9, strd.)	Torch Red (3F9)	Black (GBA)	Hypersonic Gray Metallic (GA7)	Arctic White (G8G)	Ceramic Matrix Gray Metallic (G9F)	Flare Silver Metallic (GSJ)	Accelerate Yellow Metallic (GDO)
										
		Yellow (3M9)	Orange (379)	Tension Blue (3A9)	Amplify Orange Tintcoat (GC5)	Torch Red (GKZ)	Tactical Red Tintcoat (GPH)	Caffeine Brown Metallic (G48)	Rapid Blue (GMO)	Elkhart Lake Blue Metallic (GS7)









MORELLO RED DIPPED ²²



3LT LEATHER	3LT SUEDE	AVAILABLE SEAT BELTS			AVAILABLE EXTERIOR COLORS					
HU3	-									
0 kr		Black (719, strd.)	Torch Red (3F9)		Black (GBA)	Hypersonic Gray Metallic (GA7)	Arctic White (G8G)	Ceramic Matrix Gray Metallic (G9F)	Flare Silver Metallic (GSJ)	
										
								Caffeine Brown Metallic (G48)		

TENSION/TWILIGHT BLUE DIPPED ²³



3LT LEATHER	3LT SUEDE	AVAILABLE SEAT BELTS			AVAILABLE EXTERIOR COLORS					
HTO	-									
0 kr		Black (719)			Black (GBA)	Hypersonic Gray Metallic (GA7)	Arctic White (G8G)	Ceramic Matrix Gray Metallic (G9F)	Flare Silver Metallic (GSJ)	
										
				Tension Blue (3A9, strd.)					Rapid Blue (GMO)	Elkhart Lake Blue Metallic (GS7)

²¹ Full color interior: instrument panel, doors, carpet and seat belts in Natural. Console and door panel are in sueded microfiber.

²² Full color interior: instrument panel, doors and carpet in Morello Red. Console and door panel are in sueded microfiber.

²³ Full color interior: instrument panel, doors and carpet in Tension/Twilight Blue. Seat belts are in Tension Blue.

• Standard ○ Available - Not available

3LT INTERIORS







GT2 SEATS AH2+TU7 (TWO-TONE)

Nappa leather with perforated leather seating surfaces /
Nappa leather with seating surfaces and steering wheel in perforated sueded microfiber

3LT AVAILABLE SEAT BELTS AVAILABLE EXTERIOR COLORS







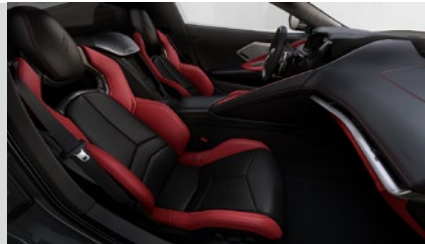

SKY COOL GRAY



HU1 + TU7 4'500 kr	HU9 + TU7 15'800 kr	 Black (719, strd.)	 Torch Red (3F9)	 Black (GBA)	 Hypersonic Gray Metallic (GA7)	 Arctic White (G8G)	 Ceramic Matrix Gray Metallic (G9F)	 Flare Silver Metallic (GSJ)	 Accelerate Yellow Metallic (GDD)
		 Yellow (3M9)	 Orange (379)	 Tension Blue (3A9)	 Amplify Orange Tintcoat (GC5)	 Torch Red (GKZ)	 Tactical Red Tintcoat (GPH)	 Caffeine Brown Metallic (G48)	 Rapid Blue (GMO)













ADRENALINE RED



HU2 + TU7 4'500 kr	HUA + TU7 15'800 kr	 Black (719, strd.)	 Torch Red (3F9)	 Black (GBA)	 Hypersonic Gray Metallic (GA7)	 Arctic White (G8G)	 Ceramic Matrix Gray Metallic (G9F)	 Flare Silver Metallic (GSJ)	
				 Torch Red (GKZ)					

NATURAL



HUE + TU7 4'500 kr	HTG + TU7 15'800 kr	 Black (719, strd.)	 Tan (3N9)	 Torch Red (3F9)	 Black (GBA)	 Hypersonic Gray Metallic (GA7)	 Arctic White (G8G)	 Ceramic Matrix Gray Metallic (G9F)	 Flare Silver Metallic (GSJ)	 Accelerate Yellow Metallic (GDD)
		 Yellow (3M9)	 Orange (379)	 Tension Blue (3A9)	 Amplify Orange Tintcoat (GC5)	 Torch Red (GKZ)	 Tactical Red Tintcoat (GPH)	 Caffeine Brown Metallic (G48)	 Rapid Blue (GMO)	 Elkhart Lake Blue Metallic (GS7)

3LT INTERIORS

COMPETITION SPORT SEATS AE4

Nappa leather with perforated leather seating surfaces /
Nappa leather with seating surfaces and steering wheel in perforated sueded microfiber

3LT
LEATHER



















SUEDE

AVAILABLE
SEAT BELTS

AVAILABLE EXTERIOR COLORS









JET BLACK



HTE	HTT	 Black (719, strd.)	 Tan (3N9)	 Torch Red (3F9)	 Black (GBA)	 Hypersonic Gray Metallic (GA7)	 Arctic White (G8G)	 Ceramic Matrix Gray Metallic (G9F)	 Flare Silver Metallic (GSJ)	 Accelerate Yellow Metallic (GDD)
0 kr	11'300 kr	 Yellow (3M9)	 Orange (379)	 Tension Blue (3A9)	 Amplify Orange Tintcoat (GC5)	 Torch Red (GKZ)	 Tactical Red Tintcoat (GPH)	 Caffeine Brown Metallic (G48)	 Rapid Blue (GMO)	 Elkhart Lake Blue Metallic (GS7)



















ADRENALINE RED



HU2	HUA	 Black (719, strd.)	 Torch Red (3F9)	 Black (GBA)	 Hypersonic Gray Metallic (GA7)	 Arctic White (G8G)	 Ceramic Matrix Gray Metallic (G9F)	 Flare Silver Metallic (GSJ)		
0 kr	11'300 kr			 Torch Red (GKZ)						



















NATURAL



HUE	HTG	 Black (719, strd.)	 Tan (3N9)	 Torch Red (3F9)	 Black (GBA)	 Hypersonic Gray Metallic (GA7)	 Arctic White (G8G)	 Ceramic Matrix Gray Metallic (G9F)	 Flare Silver Metallic (GSJ)	 Accelerate Yellow Metallic (GDD)
0 kr	11'300 kr	 Yellow (3M9)	 Orange (379)	 Tension Blue (3A9)	 Amplify Orange Tintcoat (GC5)	 Torch Red (GKZ)	 Tactical Red Tintcoat (GPH)	 Caffeine Brown Metallic (G48)	 Rapid Blue (GMO)	 Elkhart Lake Blue Metallic (GS7)

NATURAL DIPPED²⁴



HZN	HUF	 Black (719)	 Tan (3N9, strd.)	 Torch Red (3F9)	 Black (GBA)	 Hypersonic Gray Metallic (GA7)	 Arctic White (G8G)	 Ceramic Matrix Gray Metallic (G9F)	 Flare Silver Metallic (GSJ)	 Accelerate Yellow Metallic (GDD)
0 kr	11'300 kr	 Yellow (3M9)	 Orange (379)	 Tension Blue (3A9)	 Amplify Orange Tintcoat (GC5)	 Torch Red (GKZ)	 Tactical Red Tintcoat (GPH)	 Caffeine Brown Metallic (G48)	 Rapid Blue (GMO)	 Elkhart Lake Blue Metallic (GS7)

²⁴ Full color interior: instrument panel, doors, carpet and seat belts in Natural. Console and door panel are in sueded microfiber.

• Standard ○ Available – Not available

3LT INTERIORS









COMPETITION SPORT SEATS AE4

Nappa leather with perforated leather seating surfaces /
Nappa leather with seating surfaces and steering wheel in perforated sueded microfiber

3LT		AVAILABLE SEAT BELTS		AVAILABLE EXTERIOR COLORS				
LEATHER	SUEDE							



MORELLO RED DIPPED ²⁵



HU3	-	 Black (719, strd.)	 Torch Red (3F9)	 Black (GBA)	 Hypersonic Gray Metallic (GA7)	 Arctic White (G8G)	 Ceramic Matrix Gray Metallic (G9F)	 Flare Silver Metallic (GSJ)
0 kr						 Tactical Red Tintcoat (GPH)		

TENSION/TWILIGHT BLUE DIPPED ²⁶



HTO	-	 Black (719)		 Black (GBA)	 Hypersonic Gray Metallic (GA7)	 Arctic White (G8G)	 Ceramic Matrix Gray Metallic (G9F)	 Flare Silver Metallic (GSJ)
0 kr			 Tension Blue (3A9, strd.)				 Rapid Blue (GM0)	 Elkhart Lake Blue Metallic (GS7)

²⁵ Full color interior: instrument panel, doors and carpet in Morello Red. Console and door panel are in sueded microfiber.

²⁶ Full color interior: instrument panel, doors and carpet in Tension/Twilight Blue. Seat belts are in Tension Blue.

• Standard ○ Available - Not available

TIRE PRODUCT INFORMATION SHEET

DELEGATED REGULATION (EU) 2020/740

SUMMER TIRES 245/35 ZR19

Supplier name or trademark	MICHELIN
Commercial name or trade designation	PILOT SPORT 4 S
Tire type identifier	343084
Tire size designation	245/35ZR19
Load-capacity index	89
Speed category symbol	(Y)
Fuel efficiency class	D
Wet grip class	C
External rolling noise class	B
External rolling noise value	70
Severe snow tire	No
Ice tire	No
Date of start of production	21/14
Date of end of production	-
Load version	SL
Additional information	245/35 ZR19 (89Y) TL PILOT SPORT 4 S ZP MI



MICHELIN 343084

245/35ZR19 (89Y) C1

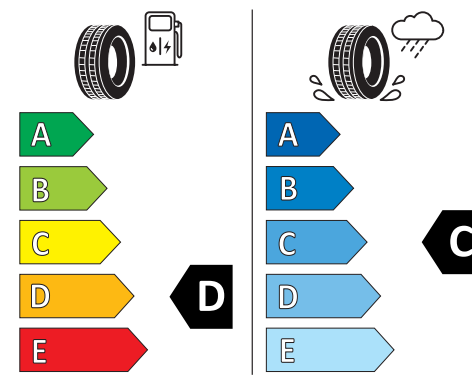

2020/740

TIRE PRODUCT INFORMATION SHEET

DELEGATED REGULATION (EU) 2020/740

SUMMER TIRES 305/30 ZR20

Supplier name or trademark	MICHELIN
Commercial name or trade designation	PILOT SPORT 4 S
Tire type identifier	633769
Tire size designation	305/30ZR20
Load-capacity index	99
Speed category symbol	(Y)
Fuel efficiency class	D
Wet grip class	D
External rolling noise class	B
External rolling noise value	73
Severe snow tire	No
Ice tire	No
Date of start of production	21/14
Date of end of production	-
Load version	SL
Additional information	305/30 ZR20 (99Y) TL PILOT SPORT 4 S ZP MI



MICHELIN 633769

305/30ZR20 (99Y) C1

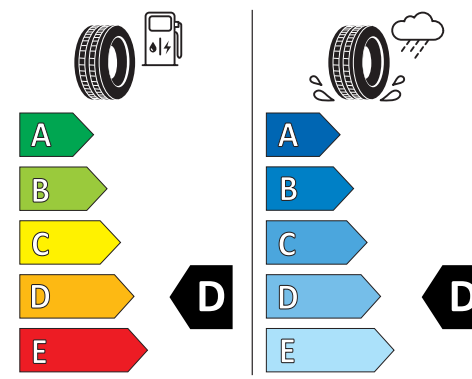

2020/740

READING THE RENEWED TIRE LABEL

Link to the relevant Commission webpage dedicated to Regulation (EU) 2020/740:
<https://eur-lex.europa.eu/legal-content/EN/TXT/?uri=CELEX%3A32020R0740>

The renewed tire label provides information about the following performance of a tire:

- 1 «Fuel efficiency» shows in 5 classes (A to E) how the tire scores on fuel consumption as a result of the tyre's rolling resistance on the road surface.
- 2 «Grip on wet road surface» indicates in 5 classes (A to E) how well the tire performs on a wet road surface.
- 3 «Noise» gives information in 3 classes (A to C) and in decibels (dB) about the amount of rolling noise of the tire.
- 4 The «snow symbol» shows whether a tire is suitable for use in severe snow conditions.
- 5 The «ice symbol» indicates whether a tire is suitable for use in very severe snow and ice conditions.

The tires under your car affect fuel consumption. The rolling resistance of the tires is responsible for approximately 20% of the car's fuel consumption. If you choose an economical tire with a good score on the tire label component fuel efficiency, you can save money every year. The savings are even greater by also keeping the tires at the correct pressure. To do this, check the tire pressure at least every 2 months and add air if necessary. This also improves grip on (wet) road surfaces, road holding, braking distance and driving comfort and reduces tire rolling noise.

In addition to rolling resistance and tire pressure, the fuel consumption of your car is determined by vehicle weight, engine type, speed and speed changes, air resistance, road slope, mechanical resistance in the drivetrain, use of air conditioning and traffic conditions. However, the most important determining factor for fuel consumption is your driving behavior. With a moderate, energy-efficient driving style, fuel consumption can be significantly reduced. For an optimal energy-efficient driving style, but above all for safety, it is important to always maintain sufficient distance from the vehicle in front, so that you don't have to brake as much as possible and, if necessary, stop in time.

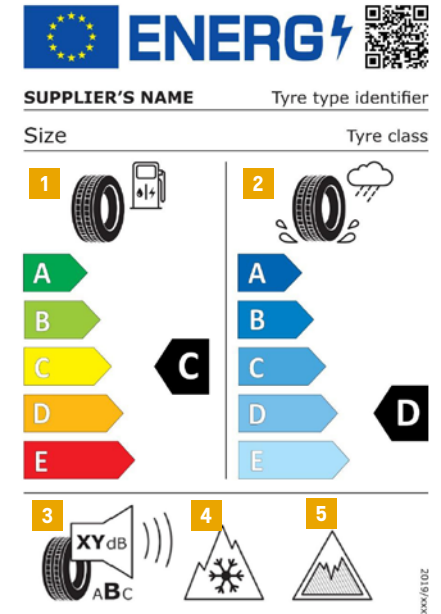

DIMENSIONS & MASSES ²⁷

COUPE

CONVERTIBLE

Mass in running order	1730–1740 kg	1767–1775 kg
Length	4634 mm	4634 mm
Width	1934 mm	1934 mm
Height	1235 mm	1234 mm
Wheelbase	2722 mm	2722 mm
Track front/rear	1647 / 1590 mm	1647 / 1590 mm

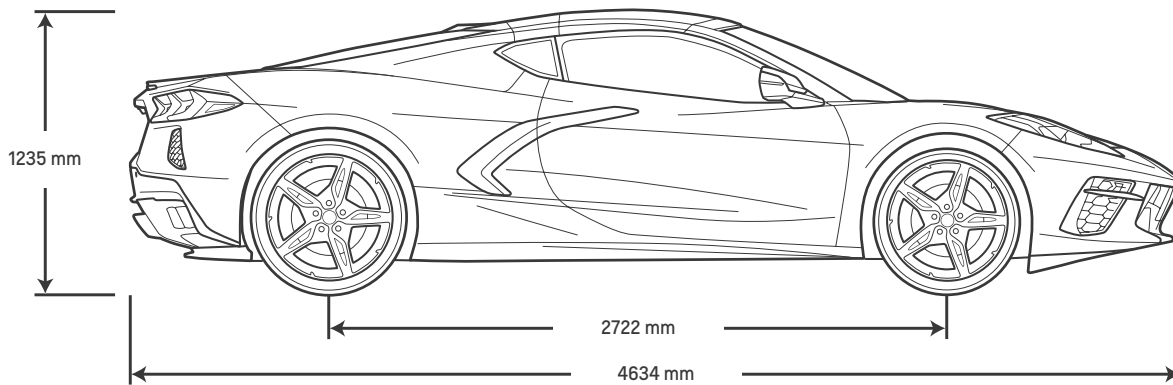

11.6 m



70 l

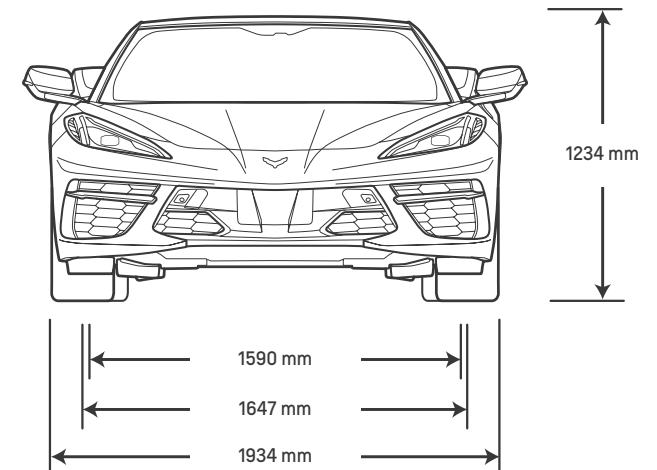
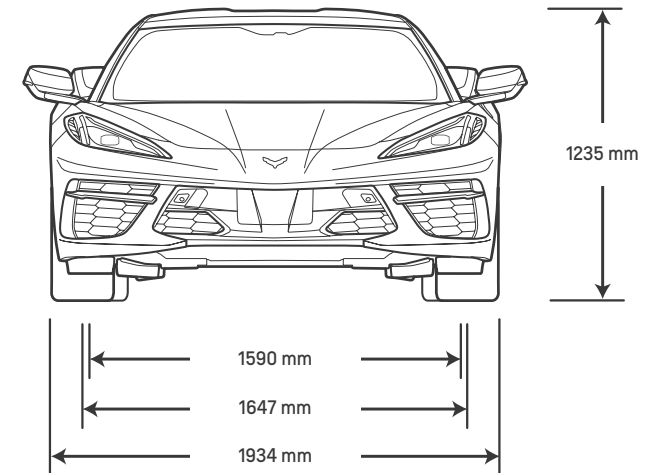
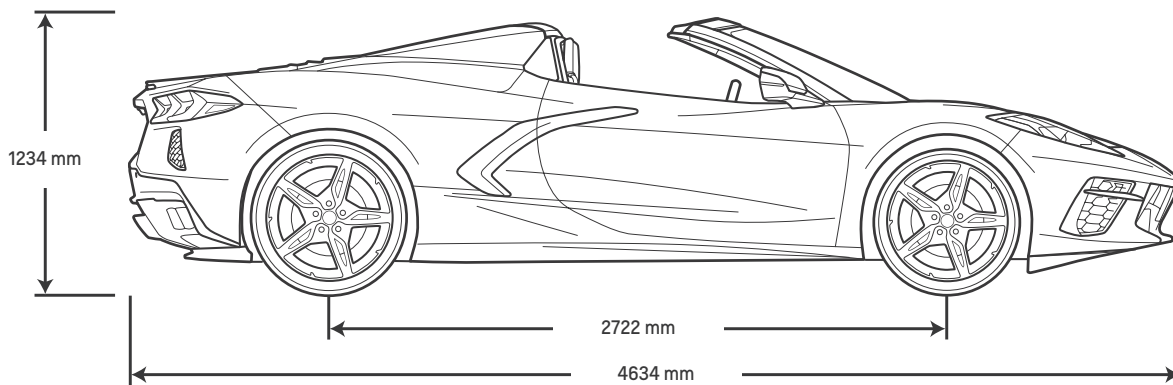

Images show US configuration which might differ from the European version.

²⁷ Masses and dimensions measured in accordance with the current version of regulation (EU) No 1230/2012.



CHEVROLET SERVICE

Whether you are at home or on the road, our Chevrolet Partner is there to offer you truly personal assistance. Count on us to arrange service appointments, answer questions about your new Chevrolet and ensure you are always satisfied with your ownership experience. To find your nearest Chevrolet Partner, visit www.chevrolet-europe.com.



WARRANTY

Every Chevrolet is built to the highest standards and is manufactured with the utmost care. As a Chevrolet owner, you can expect nothing less than premium service and protection. Should you experience defects in materials or through deficient workmanship your entire vehicle is backed by our no excess, Bumper-to-Bumper, Limited Chevrolet Warranty for three years or 100.000 km - whichever comes first, plus a 6-year anti-perforation corrosion warranty. Should the vehicle change owner, the warranty transfers automatically during the warranty period.



CHEVROLET ROADSIDE ASSISTANCE

In the event of an emergency, help is only a phone call away. Contact Chevrolet Roadside Assistance, and we'll come to you as quickly as possible – 24 hours a day, 365 days a year. If we can't return you to the road straight away, we'll take you to the nearest Chevrolet Partner. Chevrolet Roadside Assistance is yours free of charge for a period of 36 months from the date of first registration. Ask your local Chevrolet Partner for details.

PLEASE NOTE:

The information contained in this brochure was accurate at the time of going to press (September 2021). Availability, technical features and equipment provided on our vehicles can vary from one market to another and may change without prior notice. The vehicles shown in this brochure are for illustration purposes only. European specifications may vary. Some illustrations feature equipment that is not included in every model. The colors printed in the brochure only approximate actual colors. Specifications, dimensions, measurements, ratings and other numbers in this catalogue and other printed materials provided at the dealership or affixed to vehicles are approximates based upon design and engineering drawings and prototypes and laboratory tests. Your vehicle may differ due to variations in manufacture and equipment.

For precise information on the equipment provided on our vehicles, please contact your local Chevrolet Partner. This material shall not be reprinted, in whole or in part, without the express written permission of General Motors. We reserve the right to make changes at any time, without notice, to prices, colors, materials, equipment, specifications, models and availability.



SEPTEMBER 2021 (SE)

www.chevrolet.se